

ZWS SERIES

AC/DC Single Output: 5 - 150 Watts

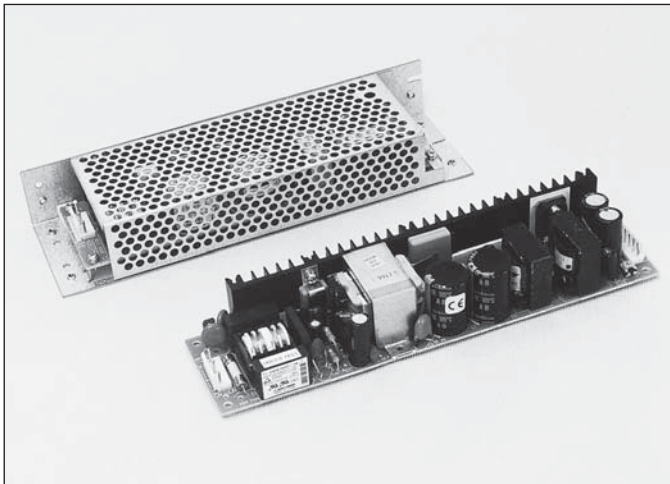

Features

- Universal input 85 - 265VAC
- Wide range of models from 5-150 watts
- Output voltage adjustment
- Short circuit and OVP protection
- Harmonic correction EN61000-3-2 (AF models)
- EMC EN55022
- Immunity to EN61000-4
- International safety approvals EN60950, UL60950
- Some modes suitable for **Battery Charging**
- Convection cooled and full power to 50°C
- Open frame or vented case options

General Specifications

Input Voltage:	85 - 264VAC, 120 - 370VDC
Power Factor:	0.95
Output Voltage:	5 - 48VDC options
Output Power:	5 - 150 watts
Voltage Adjustment:	±10% by on-board trim pot
Output Protection:	Current limiting with auto recovery OVP Protection
EMI:	EN55011 & EN55022-A
Immunity:	EN61000-4
Operating Temp:	-10°C to +50°C at 100°C load
Cooling:	Convection cooled
Connector:	JSP pluggable connector/cable harness
Dimensions & Weight:	See below

Description

The **ZWS** series DC power supply range is a mature product with over 15 years field service. They are available as an open frame for installation and integration within customers end products or with a vented case for industrial applications.

A wide range of voltage options 5 - 48VDC and eight power levels from 5 watts to 150 watts.

On some models, the output protection is a **constant current** characteristic, making the product suitable for battery charging applications. They can be used as a combined power supply/battery charger as is, or can be integrated into customers own equipment with a variety of added monitoring and alarm features.

International safety approvals ensure risk free compliance for OEM products.

For low quantity orders, all units are shipped with input and output cable harnesses, providing a simple and complete power supply solution.

Options

Stand Alone Style: The 50 - 150 watt models are available as a stand-alone/fully enclosed unit.
See BDA Series.

Vented Case: All models are available as an *Open Frame* or in a *Vented Case* style - **JA**.

Cable Harness: For low volume orders, units are shipped with input and output cable harnesses. For OEM/Volume applications, this is an option allowing customers the option of making their own harnesses.

Cable Harness Part No's:

H-IN-5L:	Input 5 - 150W models
H-OU-8L:	Output 5 - 15W models
H-OU-9L:	Output 30 - 50W models
H-OU-18L:	Output 75W models
H-OU-10L:	Output 100W models
H-OU-11L:	Output 150W models
H-OU-12L:	Output 150W models

	L	W	H	Weight:
Open Frame				
ZWS5	98	45	21mm	65g
ZWS10	105	50	21mm	75g
ZWS15	125	50	21mm	95g
ZWS30	133	55	26mm	200g
ZWS50	195	55	26mm	250g
ZWS75	222	55	35mm	320g
ZWS100	222	62	35mm	360g
ZWS150	222	75	40mm	510g
Vented Case				
ZWS5-A	118	52	32mm	180g
ZWS10-A	125	57	32mm	200g
ZWS15-A	145	57	32mm	300g
ZWS30-A	163	65	36mm	370g
ZWS50-A	225	65	36mm	500g
ZWS75-A	252	65	43mm	900g
ZWS100-A	253	72	45mm	900g
ZWS150-A	252	85	51mm	1400g

ZWS SERIES

AC/DC Single Output: 5 - 150 Watts

Model	Output		Power W
	V	A	
ZWS5 - 3 - JA	3.3V	1.0A	3W
ZWS5 - 5 - JA	5V	1.0A	5W
ZWS5 - 12 - JA	12V	0.42A	5W
ZWS5 - 15 - JA	15V	0.34A	5W
ZWS5 - 24 - JA	24V	0.22A	5W
ZWS10 - 3 - JA	3.3V	2.0A	6.6W
ZWS10 - 5 - JA	5V	2.0A	10W
ZWS10 - 12 - JA	12V	0.85A	10W
ZWS10 - 15 - JA	15V	0.7A	10W
ZWS10 - 24 - JA	24V	0.45A	10W
ZWS15 - 3 - JA	3.3V	3.0A	10W
ZWS15 - 5 - JA	5V	3.0A	15W
ZWS15 - 12 - JA	12V	1.25A	15W
ZWS15 - 15 - JA	15V	1.0A	15W
ZWS15 - 24 - JA	24V	0.65A	15W
ZWS30 - 3 - JA	3.3V	6.0A	20W
ZWS30 - 5 - JA	5V	6.0A	30W
ZWS30 - 12 - JA	12V	2.5A	30W
ZWS30 - 15 - JA	15V	2.0A	30W
ZWS30 - 24 - JA	24V	1.3A	30W
ZWS30 - 36 - JA	36V	0.9A	30W
ZWS30 - 48 - JA	48V	0.7A	30W
ZWS50 - 3 - JA	3.3V	10.0A	33W
ZWS50 - 5 - JA	5V	10.0A	50W
ZWS50 - 12 - JA	12V	4.3A	50W
ZWS50 - 15 - JA	15V	3.5A	50W
ZWS50 - 24 - JA	24V	2.1A	50W
ZWS50 - 36 - JA	36V	1.4A	50W
ZWS50 - 48 - JA	48V	1.1A	50W

Model	Output		Power W
	V	A	
ZWS75AF - 3 - JA	3.3V	15A	50W
ZWS75AF - 5 - JA	5V	15A	75W
ZWS75AF - 12 - JA	12V	6.3A	75W
ZWS75AF - 15 - JA	15V	5A	75W
ZWS75AF - 24 - JA	24V	3.2A	75W
ZWS75AF - 36 - JA	36V	2.1A	75W
ZWS75AF - 48 - JA	48V	1.6A	75W
ZWS100AF - 3 - JA	3.3V	20A	66W
ZWS100AF - 5 - JA	5V	20A	100W
ZWS100AF - 12 - JA	12V	8.5A	100W
ZWS100AF - 15 - JA	15V	6.7A	100W
ZWS100AF - 24 - JA	24V	4.3A	100W
ZWS100AF - 36 - JA	36V	2.8A	100W
ZWS100AF - 48 - JA	48V	2.1	100W
ZWS150AF - 3 - JA	3.3V	30A	99W
ZWS150AF - 5 - JA	5V	30A	150W
ZWS150AF - 12 - JA	12V	12.5A	150W
ZWS150AF - 15 - JA	15V	10A	150W
ZWS150AF - 24 - JA	24V	6.3A	150W
ZWS150AF - 36 - JA	36V	4.2A	150W
ZWS150AF - 48 - JA	48V	3.2A	150W
ZWSPF: Battery Charging Models			
ZWS75PF - 15 - JCA	15V	5.0A	75W
ZWS100PF - 15 - JCA	15V	6.7A	100W
ZWS150PF - 15 - JCA	15V	10.0A	150W
ZWS75PF - 28 - JCA	28V	2.7A	75W
ZWS100PF - 28 - JCA	28V	3.6A	100W
ZWS150PF - 28 - JCA	28V	5.4A	150W



Alternative case - see BDA Series

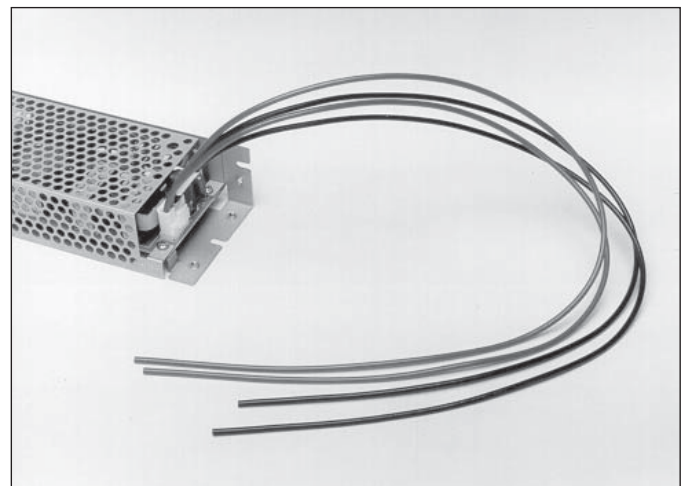

1. Optional Cable harness (illustrated)
2. Output length 0.5m
3. Input length 1m

ZWS SERIES

AC/DC Single Output: 5 - 150 Watts

ZWS5 (J Type: JST connector)

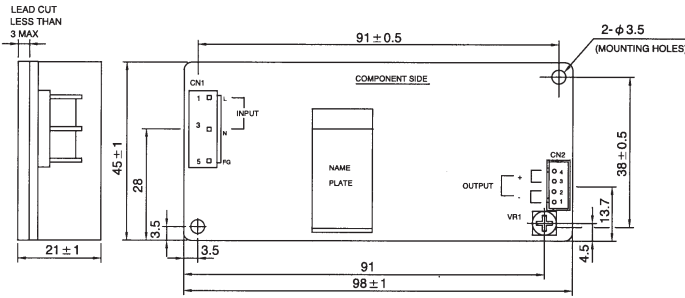

ZWS5 (JA Type: With cover type)

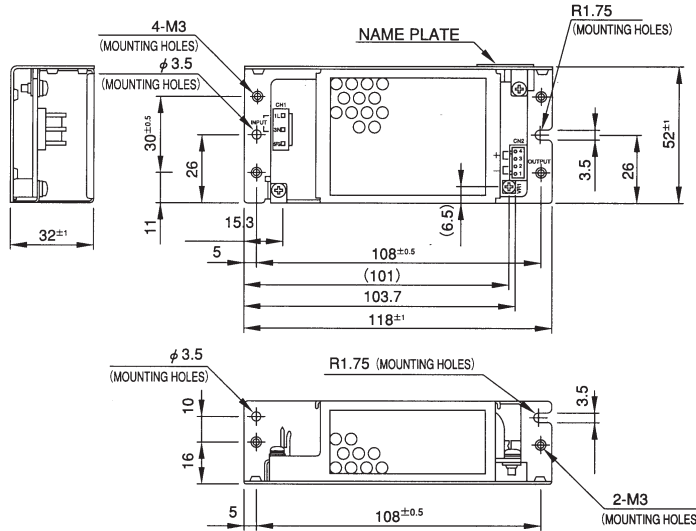

ZWS10 (J Type: JST connector)

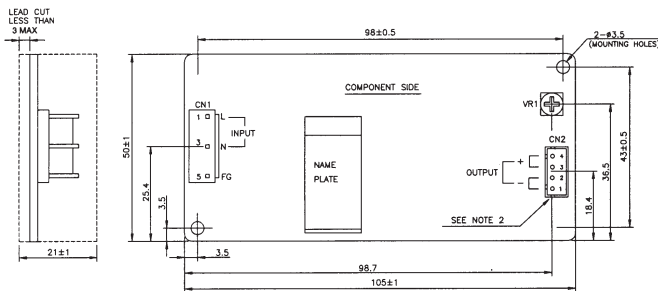

ZWS10 (JA Type: With cover type)

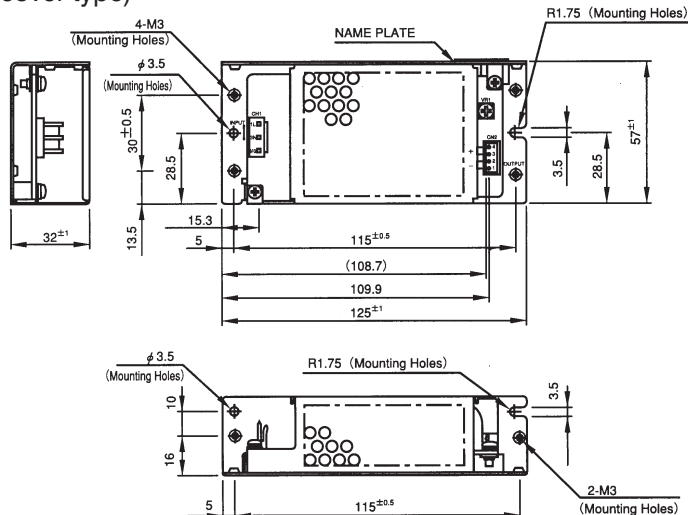

Units mm

ZWS SERIES

AC/DC Single Output: 5 - 150 Watts

ZWS15 (J Type: JST connector)

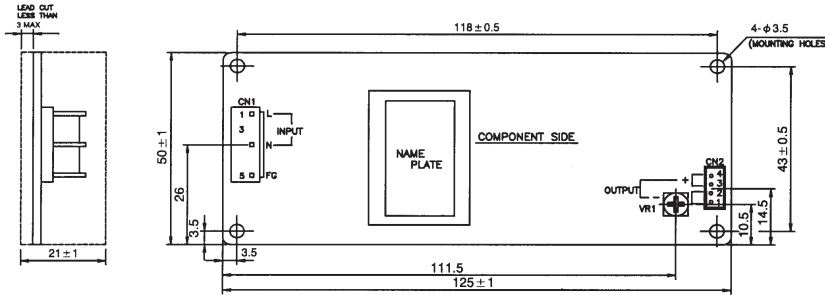

ZWS15 (JA Type: With cover type)

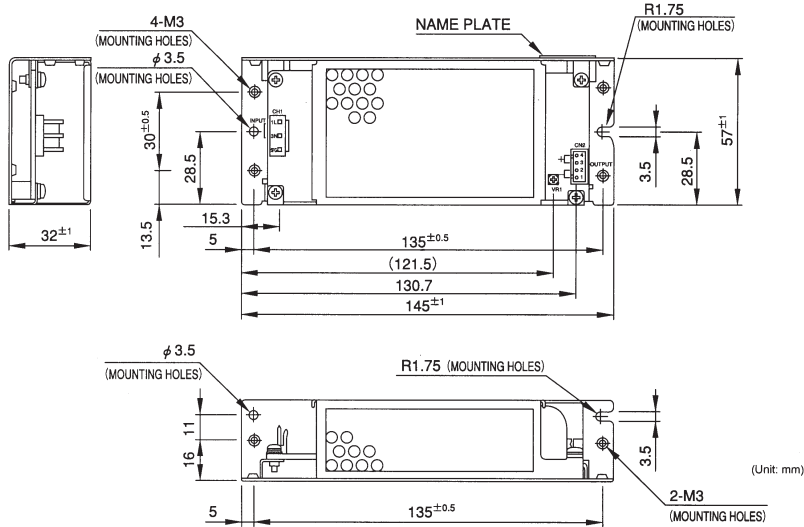

ZWS30 (J Type: JST connector)

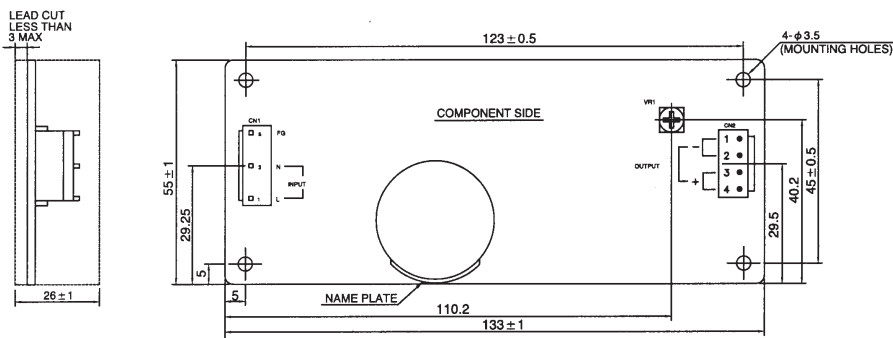

ZWS30 (JA Type: With cover type)

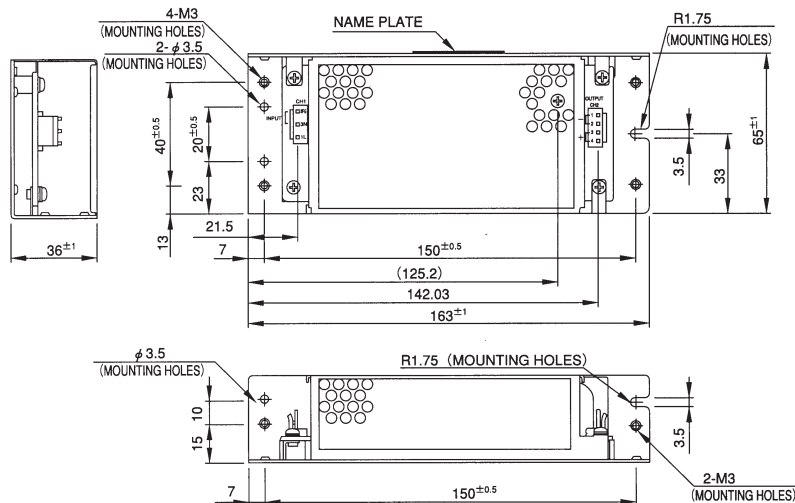

Units mm

ZWS SERIES

AC/DC Single Output: 5 - 150 Watts

ZWS50 (J Type: JST connector)

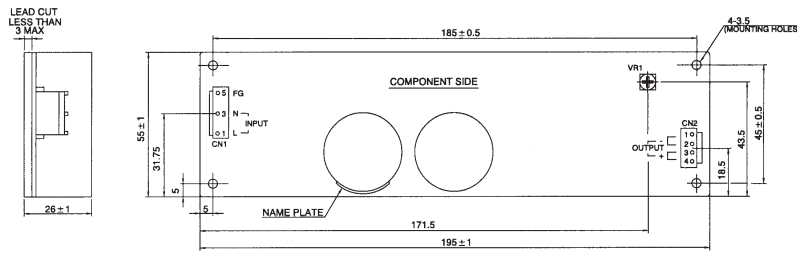

ZWS50 (JA Type: with cover type)

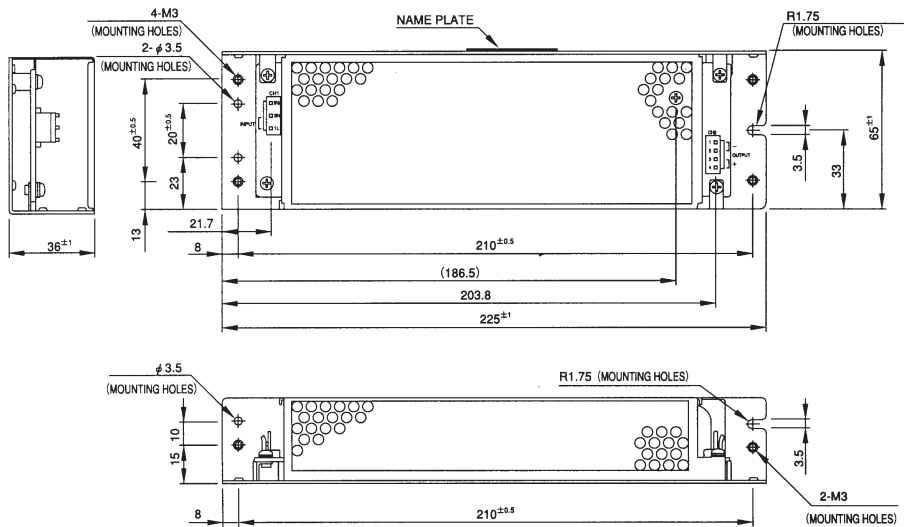

ZWS75 (J Type: JST connector)

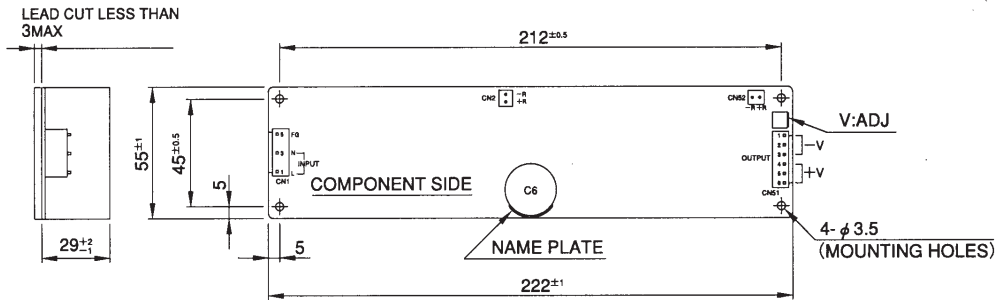

ZWS75 (JA Type: with cover type)

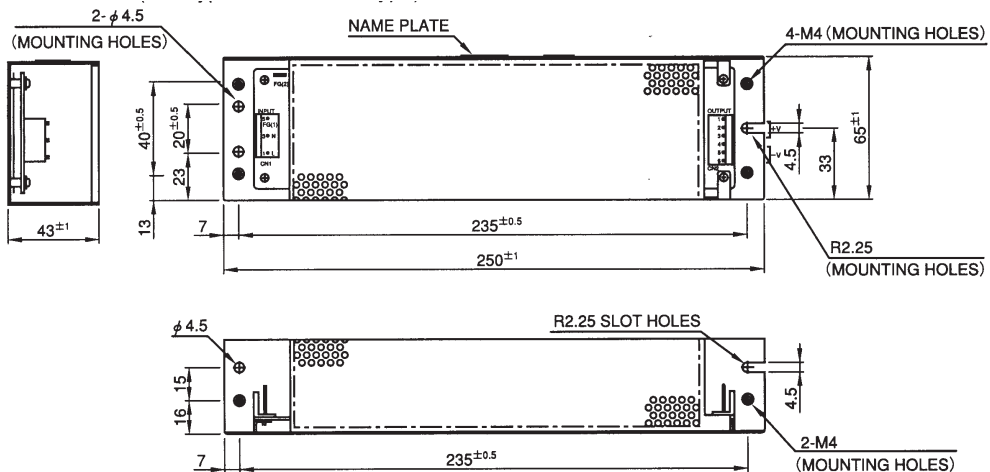

Units mm

ZWS SERIES

AC/DC Single Output: 5 - 150 Watts

ZWS100 (J type: JST connector)

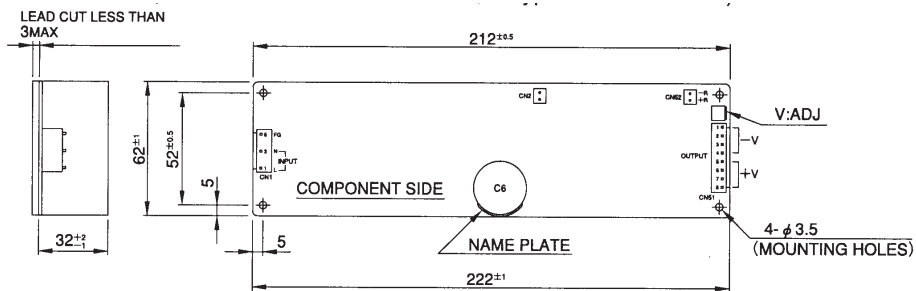

ZWS100 (JA type: with cover type)

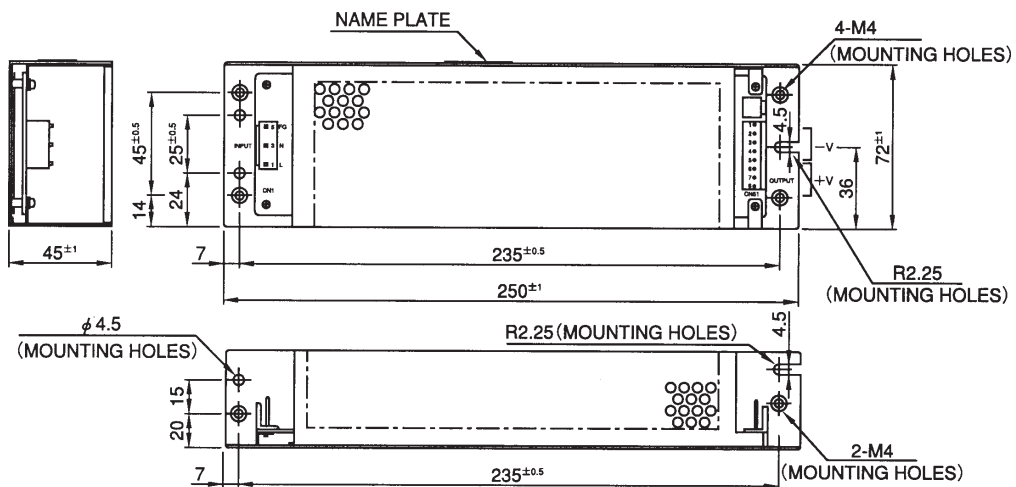

ZWS150 (J Type: JST connector)

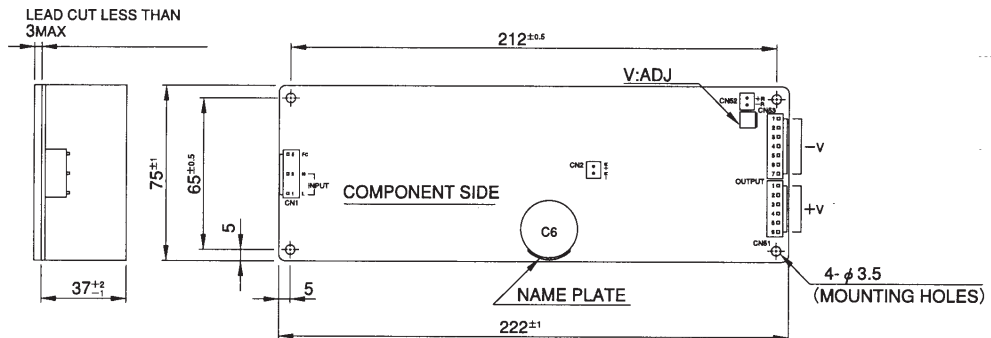

ZWS150 (JA Type: with cover type)

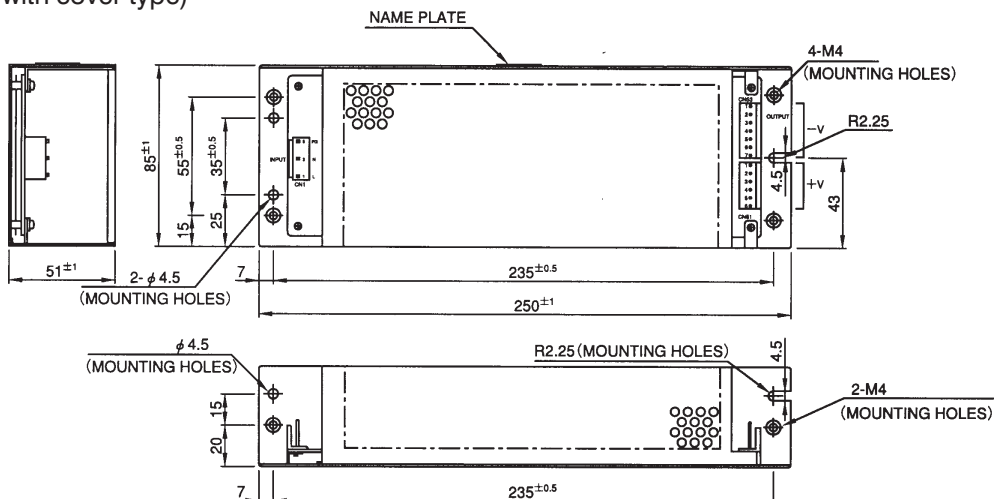

Units mm